

MODEL TA-LF

THERMOSTATIC MIXING VALVES

ECO-MIX™

TA-LF-F



TA-254-LF

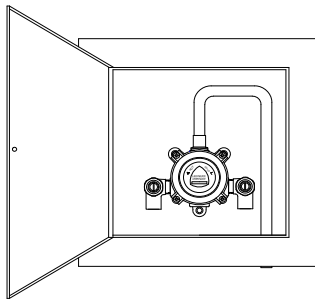

Valve assembly is certified to meet Low-Lead requirements of wetted surface area containing less than 0.25% lead by weight. All other fittings and components, the sum total of which comprise the wetted surface of this product contains less than one quarter of one percent of lead by weight.

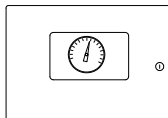

SUFFIX VIEW

Engineer's Approval	Job # _____
	Arch/Eng. _____
	Contractor _____

Note: Leonard Valve Company reserves the right of product, or design modifications without notice or obligation.

© 2019 Leonard Valve Company
Printed in USA

- TA-LF-F
- TM-554-TA-LF
- TA-254-LF
- TA-254T-LF

- TA-LF-F, 1/2" angle checkstops, sweat connections
 - Thermostatic mixing valve for critical line control/process applications
 - DURA-trol® solid bimetal thermostat directly linked to valve porting to control the intake of hot and cold water and compensate for supply temperature or pressure fluctuations. DURA-trol® is highly responsive and cannot be damaged by extremes in temperature.
 - .5 GPM (1.9 l/m) minimum flow capacity
 - Integral combination checkstops
 - Internal parts of lead free bronze, lead free brass, and stainless steel
 - Temperature selector handle with scale: COLD-HOT
 - Maximum operating pressure 125 PSI (860 KPA)
 - Adjustable high temperature limit stop set for 110° F (43° C)
- TM-554-TA-LF, 1/2"
 - Thermostatic Water Mixing Valve
 - Inlet Checkstops
 - Outlet piping with ball valve and dial thermometer
- TA-254-LF-STSTL CABINET ASSEMBLY, 1/2"
 - Thermostatic Water Mixing Valve
 - Bottom inlet and outlet piping with copper tube connections
 - Stainless steel recessed cabinet, #4 finish, with door, left-hand hinge, flange, and cylinder lock
 - Factory assembled and tested
- TA-254T-LF-STSTL CABINET ASSEMBLY, 1/2"
 - As above with top outlet

OPTIONS:

- SUFFIX DT - With dial thermometer, shipped loose, TA-LF-F only (for cabinet assemblies choose "37C" option below)
- SUFFIX WS - Wall support (TA-LF-F only, all others WS is standard)
- SUFFIX BWE REC - Steel cabinet, baked white enamel recessed
- SUFFIX STSTL REC - Stainless steel recessed cabinet
- SUFFIX BWE EXP - Exposed baked white enamel cabinet
- SUFFIX STSTL EXP - Exposed cabinet, stainless steel
- SUFFIX NI - Nickel plated
- SUFFIX 37C - With dial thermometer, only for cabinet assemblies, (for TA-LF-F choose "DT" option above)
- SUFFIX TOP - Top inlets (TA-254-LF-T only)
- SUFFIX VIEW - Viewport for thermometer in door



WARNING: This product can expose you to chemicals including lead, which is known to the State of California to cause cancer. For more information, go to www.P65Warnings.Ca.gov

1360 Elmwood Avenue, Cranston, RI 02910 USA
Phone: 401.461.1200 Fax: 401.941.5310
Email: info@leonardvalve.com
Web Site: <http://www.leonardvalve.com>

TA-LF-F

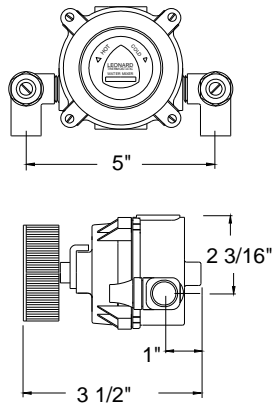

TM-554-TA-LF

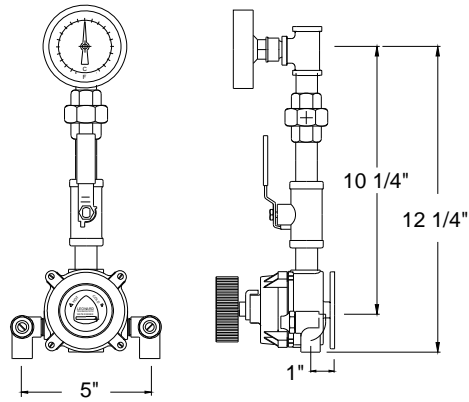

TA-254-LF

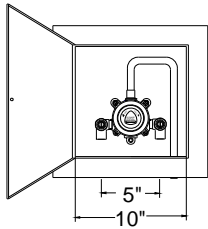

TA-254T-LF

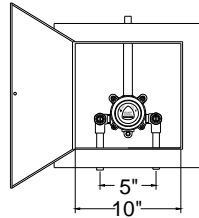

TA-254T-LF-37C

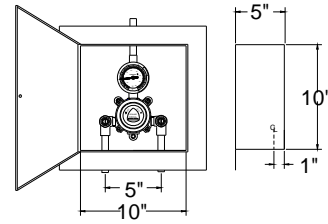

FLOW CAPACITIES

MODEL	IN	OUT	MINIMUM FLOW (GPM) L/MIN	PRESSURE DROP								PSI BAR
				5	10	20	30	40	45	50	PSI BAR	
TA-LF	1/2"	1/2"	0.5	2.0	4	5.5	7	8	8.5	9.0	GPM	
			1.9	7.6	15	21	26	30	32	34	L/MIN	

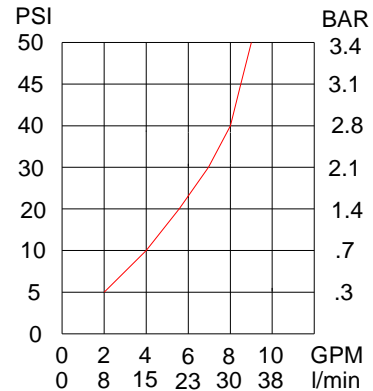

CAUTION! All thermostatic water mixing valves have limitations. They will NOT provide the desired accuracy outside of their flow capacity range. Consult the Flow Capacity Chart and DO NOT OVERSIZE. Minimum flow must be no less than as indicated.

***NOTE:** A limit stop, set for 110°F (43°C), is simply a mechanical setting to prevent excessive handle rotation. If incoming water is hotter than 135°F (57°C), the temperature of the factory test, the valve when turned to full HOT may deliver water in excess of 110°F and the limit stop MUST BE RESET BY THE INSTALLER



1360 Elmwood Avenue, Cranston, RI 02910 USA
 Phone: 401.461.1200 Fax: 401.941.5310
 Email: info@leonardvalve.com
 Web Site: <http://www.leonardvalve.com>